



ITEM# SNAP3
AUTOMOTIVE NAVIGATION SYSTEM (GPS)



HARDWARE INSTRUCTION

Copyright Notice

© 2007 All rights reserved. No part of this document may be reproduced or transmitted in any form or by any means, electronic or mechanical, for any purpose, without the express written permission of the seller.

Disclaimer

Information in this document is subject to change without notice. The statements, configurations, technical data, and recommendations in this document are believed to be accurate and reliable, but are presented without express or implied warranty. The seller therefore assumes no responsibility and shall have no liability of any kind arising from the supply or use of this document or the material contained herein.

Statement of Conditions

In the interest of improving internal design, operational function, and/or reliability, the seller reserves the right to make changes to the products described in this document without notice.

The seller does not assume any liability that may occur due to the use or application of the product(s) or circuit layout(s) described herein.

In addition, the program and information contained herein are licensed only pursuant to a license agreement that contains restrictions on use and disclosure (that may incorporate by reference certain limitations and notices imposed by third parties).

Trademarks

All other product or service names mentioned in this document may be trademarks of the companies with which they are associated.

RoHS&FCC

Askey Computer Corp. recognizes the need to be a responsible corporate citizen. With respect to the current EU directives and the equivalent domestic legislation which implement the Restriction of Hazardous Substances (RoHS), Askey is committed to producing products supplied into the EU that are fully compliant to the directives on or before their respective effective dates.



This device complies with Part 15 of the FCC Rules. Operation is subject to the following two conditions:

- (1) this device may not cause harmful interference, and
- (2) this device must accept any interference received, including interference that may cause undesired operation.



Safety and Precaution

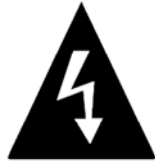

Caution

TO REDUCE THE RISK OF ELECTRIC SHOCK, DO NOT REMOVE COVER (OR BACK). NO USE-SERVICEABLE PARTS INSIDE. REFER SERVICING TO QUALIFIED SERVICE PERSONNEL.



The lightning flash with arrowhead symbol, within an equilateral triangle, is intended to alert the user to the presence of un-insulated “dangerous voltage” within the product’s enclosure that may be of sufficient magnitude to constitute a risk of electric to persons.



The exclamation point within an equilateral triangle is intended to alert the user to the presence of important operating and maintenance (servicing) instructions in the literature accompanying the appliance.

WARNING: TO REDUCE THE RISK OF FIRE OR ELECTRIC SHOCK, DO NOT EXPOSE THIS APPLIANCE TO RAIN OF MOISTURE.

POWER SUPPLY:

Connect one end of the supplied adapter to the miniUSB port of the unit. Plug the two-prong end of the power cord to an AC 100-240V outlet. If you have difficulty inserting the plug, turn it over and reinsert it. If the unit will not be used for a long time, disconnect the plug from the outlet.



Note

Before plugging the power cord into an AC outlet, make sure that all the connections have been made.



Caution

These servicing instructions are for use by qualified service personnel only. To reduce the risk of electric shock, do not perform any servicing other than that contained in the operating instructions unless you are qualified to do so. Refer to service manual for servicing instructions.

Before and when using the product, carefully read the following notes.

- For your safety, do not operate the product while driving.
- Use this product prudently. The product is intended to be used only as a navigation aid. It is not for precise measurement of direction, distance, location or topography.
- The calculated route is given for reference only. It is the your responsibility to follow the traffic signs and local regulations along the roads.
- When you get off the car, do not leave your device on the dashboard that is subject to direct sunlight. The overheating of the battery might cause malfunction and/or danger.
- GPS is operated by the United States government, which is solely responsible for the performance of GPS. Any change to the GPS system might affect the accuracy of all GPS equipment.
- GPS satellite signals cannot pass through solid materials except glass. When you are inside a tunnel or building, GPS positioning is not available.
- A minimum of 4 GPS satellite signals is needed to determine current GPS position. Signal reception might be affected in situations, such as bad weather or dense overhead obstacles (e.g. trees and tall buildings).
- Other wireless devices in the vehicle might interfere with the reception of satellite signals and cause the reception to be unstable.
- A car holder is needed when you use the device in a car. Be sure to place the device in an appropriate place so as not to obstruct the driver's view, or deployment of airbags.

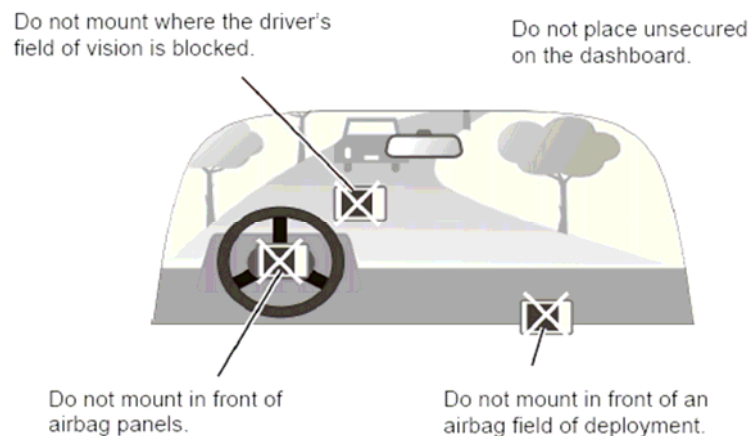

Contents

Before You Use..... vii

 PACKING LIST..... VII

 NAVIGATION FUNCTION..... VII

Chapter 1

 Getting Started..... 1

 HARDWARE FEATURES 1

 Front View 1

 Back View..... 1

 Left And Right Side Views 2

 Top And Bottom Views 3

 INITIALLY SWITCHING ON THE GPS 3

 CONNECTING TO AC POWER AND CHARGING THE BATTERY 4

 USING YOUR DEVICE IN A CAR 5

 Installing the Car Holder..... 5

 Connecting the Car Charger 6

 CONNECTING TO A PC 7

Chapter 2

 Basic Operation 9

 POWER ON AND OFF 9

 OPERATING THE DEVICE..... 9

 SYSTEM VOLUME CONTROL 10

 HOLD KEY 10

 MAIN MENU 11

 Setup Submenu..... 12

 INSERTING A MINISD CARD 12

 CONNECTING AN EARPHONE..... 13

Chapter 3

 Device Settings..... 15

 CLOCK 15

 Time Zone 16

 Date..... 16

 Time..... 17

 VOLUME 17

 BATTERY 18

 DISPLAY 19

 BLUETOOTH..... 20

 SYSTEM..... 21

Chapter 4

 Main Menu 23

 NAVIGATOR..... 23

 PHOTO 24

 Viewing Photos..... 25

 Using the slideshow 26

MP3 PLAYER..... 26
 Operation on MP3 Player..... 28
BT CARKIT 29
 Contact Viewer 30
 Call History 30
 Phone Shell 31
CALCULATOR 31

Before You Use

Before using the GPS, read the user manual attached in the package and check whether or not spare parts are attached. Feel free to contact your retailer if you have any question or problem at the time of operation.

Packing list

Before using the GPS, check all the following items are present and in good condition. If any of the items is damaged or missing, contact your retailer immediately.

- ✓ GPS x 1
- ✓ AC Power Adapter x 1
- ✓ Car Adapter x 1
- ✓ miniUSB Cable x 1
- ✓ Stylus x 1 (attached to the product)
- ✓ Car Jacket x 1
- ✓ Car Mount x 1
- ✓ Dashboard Mount Disk x 1
- ✓ Carry Pouch x 1
- ✓ User Manual x 2 (Hardware User Manual and Software User Manual)
- ✓ Quick Start Guide x 1

Navigation Function

The unit is designed to provide you with route suggestions. It supports voice navigation.

Other Special Functions

- **MiniSD Card and miniUSB Input**
The unit is designed with a miniSD card slot for file transfer between a card and the product, and with a miniUSB port for file transfer between the product and a PC.
- **Power Adapter Switch**
Automatically adapting to voltage requirements in U.S and other countries.
- **Bluetooth Support**
Allowing the product to work in Hand-Free Profile mode and A2DP mode
- **Supporting MP3 Player and Photo Viewer**

Notes and Cautions

Note and **Caution** in this manual are highlighted with graphics as below to indicate important information.



Note

Contains information that corresponds to a specific topic.



Caution

Represents essential steps, actions, or messages that should not be ignored.

This User's Manual contains information on how to install and configure your GPS device. From now on, we will guide you through the correct configuration steps to implement your device.

Chapter 1 Getting Started

Hardware Features



Note

Depending upon the specific model you purchased, the color of your device may not exactly match that of device shown in this manual.

Front View

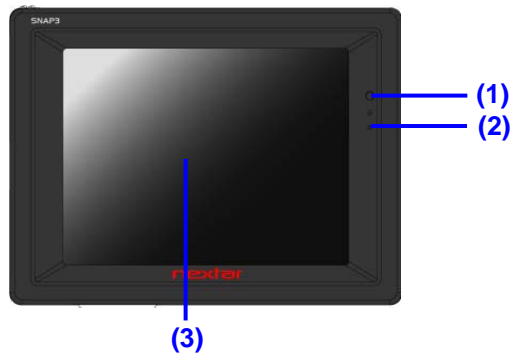

Number	Component	Description
1	Charge Indicator	When LED is red, the battery is being charged; when LED is green, the battery is fully charged.
2	Microphone	You can speak through the component in the hand-free profile mode.
3	3.5" LCD Panel	Displays the output of your device. Tap the screen with a fingertip to select a menu or read information.

Back View

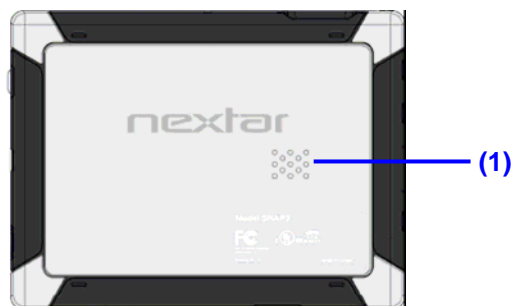

Number	Component	Description
1	Speaker	Sends out music, sounds, and voice.

Left And Right Side Views

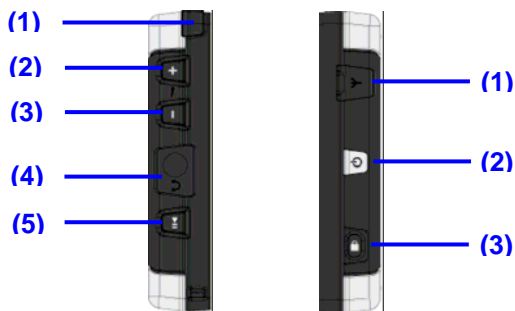

Number	Component	Description
1	Stylus	You can tap the screen with the stylus.
2	Volume Up Key	You can tune up the volume of the headphone or speaker.
3	Volume Down Key	You can tune down the volume of the headphone or speaker.
4	Headphone Jack	Used to connect a headphone for private listening. When the headphone is connected to this jack, the speaker will be turned off automatically.
5	Play / Pause Key	You can use the key to play back or pause music.
6	External GPS Antenna Connector	This connector (under rubber dust cover) allows use of an optional external antenna with magnetic mount, which may be positioned on top of the car for better signal reception in areas with poor reception.
7	Power Button	Turns on and off the device.
8	Hold Key	Designed to prevent you from operation by mistake.

Top and Bottom Views

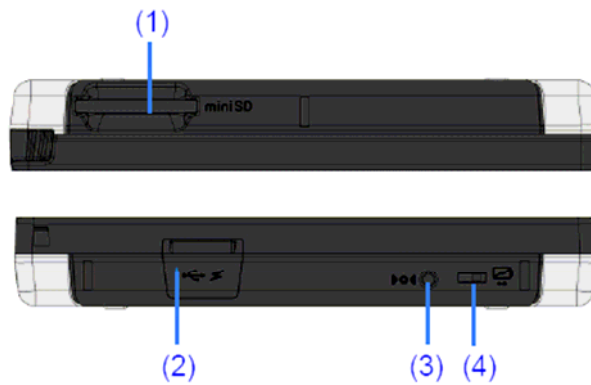

Number	Component	Description
1	MiniSD Card Slot	Accepts a MiniSD card for accessing data, such as MP3 music and photos.
2	MiniUSB Port	Connects through an AC adapter or USB cable to a PC or a car charger socket.
3	Reset Key	Restarts your device (soft reset).
4	Battery Switch	The main power/battery cutoff switch.

Initially Switching ON the GPS

Use a stylus to slide the ON/OFF switch to the **ON** position.



Then, your product will be turned ON. Connect the AC adapter as described below. Bear in mind to fully charge the battery before using your product for the first time.



Always keep the ON/OFF switch in the ON position for normal operation.

Connecting to AC Power and Charging the Battery

For the first time, you should charge it for at least 8 hours.

Follow the 2 steps below to charge the battery.

1. Connect the AC power adapter to the miniUSB port.
2. Plug the AC adapter into a wall outlet.



The charge indicator glows red when the battery is being charged. Do not disconnect your device from AC power until the battery is fully charged and the charge indicator turns green. This will take a couple of hours.



Note

-
1. *Do not immediately turn on your device after connecting the AC adapter to charge a power-consumed battery. If you need to turn ON the device again, wait at least one minute.*
 2. *Depending on your region of purchase, the connector converter may not look exactly same as that in the picture shown above.*
 3. *Your device can also be charged when it is connected to a desktop computer via a USB cable.*
-



Caution

For optimal performance of the lithium battery, bear in mind the following notes:

1. *Do not charge the battery when the surrounding temperature is high (e.g. in direct sunlight).*
 2. *There is no need to fully discharge the battery before charging. You can charge the battery before it is discharged.*
 3. *If you will not use the product for a long period of time, be sure to fully charge the battery at least once in two weeks. Over discharge of the battery can affect the charging performance.*
-

Using Your Device in a Car

A car holder and a car charger are supplied with your device.

Installing the Car Holder



Caution

Select an appropriate location for the car holder. Never place the holder where the driver's field of vision is blocked. If the car's windshield is tinted with a reflective coating, an external antenna (optional) may be needed to route to the top of the car through a window. When closing the car window, be careful not to pinch the antenna cable. (An adequate space may be left, as needed, for a car with an anti-jamming window design.)

The car holder consists of a car jacket and a car mount. Use the car holder to fix your device in a vehicle. Make sure that the GPS antenna has a clear view of the space.

For initial positioning, remain at the same spot with a clear view of the space. The GPS may take a few minutes to find its current location initially.

Please follow the illustrative step-by-step instruction given below to assemble the car holder.

Step 1:

Take a car jacket and a car mount out of the package box.

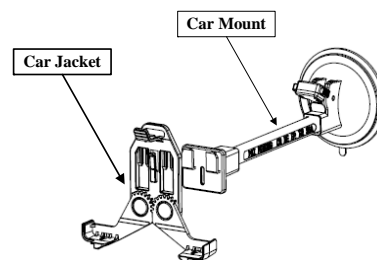

Step 2:

Insert 2 lugs formed at one end of the car mount into 2 wedged slots formed on the car jacket.

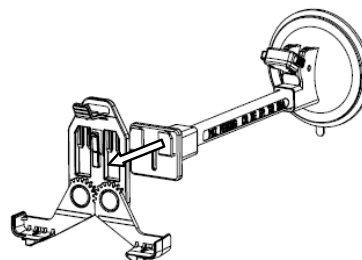

Step 3:

Push upward the car mount to tightly wedge the 2 slots formed on the car jacket.

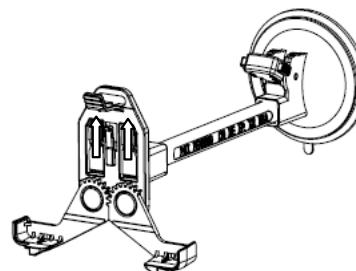

Step 4:

Push the car mount lock towards the sucking disc to make the disc tightly suck the windshield of your car.

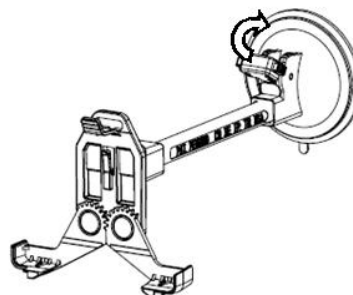

Step 5:

Set the GPS product downwards and inward at the degree of 15 towards 2 sides of lower hooks of the car jacket; then, push the product backwards to wedge the upper hook of the car jacket.

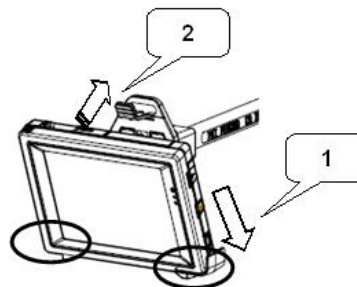

Step 6:

The installation of the car holder is completed.



Connecting the Car Charger

The car charger supplies power to your device you are using in a car.



To protect your device against sudden surges in current, connect the car charger only after the car engine has been started.

Follow the instructions below to connect the car charger to the car cigarette socket.

1. Connect one end of the car charger to the power connector of your device.
2. Connect the other end to the 5V cigarette lighter in the car to power and charge your device. The indicator on the car charger lights in green to indicate that power is being supplied to your device.



Connecting to a PC

**Note**

Always ensure that the GPS device and any other external device connected to the GPS device are switched off and unplugged from the power supply before you attempt to connect the GPS device to any external device.

The GPS device is designed with a miniUSB port that allows you to connect the device to a PC for file transfer and battery charging.

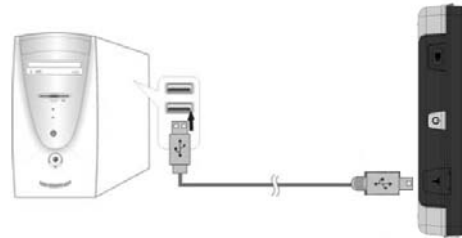

The requirements of the PC are listed below.

- Windows 98SE, ME, 2000, or XP (Driver required for Windows 98SE)
- Intel Pentium II 233 MHz
- 64 MB RAM
- Hard drive space of 50MB available
- USB Port available
- 256-color display (16 bit color required)

Chapter 2 Basic Operation

Power ON and OFF

Use the power button  to power ON and OFF your device.

When you press the power button to turn off the product, your device actually enters a suspend mode and the system stops operating. Once you power ON the system again, it resumes.



Operating the Device

To operate your device, touch the screen with a stylus or your fingertip. You can perform the following actions.

- **Tap**

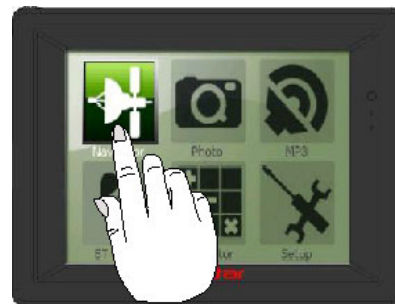

Touch the screen with the stylus or your fingertip to open the menu or an item.





- **Drag**

Hold the stylus or your fingertip on the screen and drag up/down/left/right or across the screen to view photos.

System Volume Control

To Increase or decrease the volume, you can press the **Volume Up** Key  or the **Volume Down** Key .



Whenever pressing the **Volume Up** Key  or the **Volume Down** Key , you will see the system volume scale right below on the screen.



Hold Key

To prevent you from operation by mistake, you can press the hold key , even before putting the product in your pocket.



Whenever pressing the hold Key , you will see the small lock icon on the screen.



Main Menu

At the first time which you initialize your device, the Main Menu appears in about 3~5 seconds. The Main Menu is your starting place for various tasks. Tap a button to start a task or open another menu.

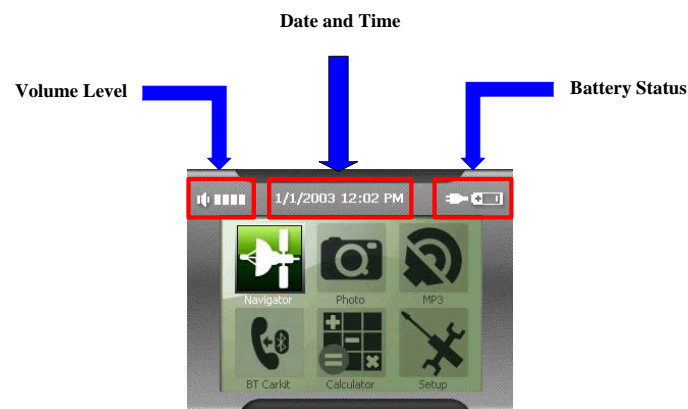

Note

To adjust the current time, click **Date and Time** just above the **Photo** icon. Refer to **Chapter 3** for the details.

Button Name	Description
Navigator	Entering the GPS navigation service
Photo	Allowing you to view pictures in the formats of BMP, JPG, and GIF that were stored in a miniSD card
MP3	Allowing you to enjoy songs in the formats of MP3 and WMA that were stored in a miniSD card
BT CarKit	Allowing you to talk on the device by means of Bluetooth wirelessly connected to your BT mobile phone
Calculator	Allowing you to do calculation
Setup	Entering to customize the device settings, such as backlight, volume, date and time, as briefly described below

Setup Submenu

On this setting page, you can customize the device settings, such as backlight, volume, date and time. Once you change the settings, your new settings will remain until you change them again.



Button Name	Description
Clock	Allowing you to select a Time Zone and set the current date and time
Volume	Allowing you to enable or disable the key tone of touch pad and adjustment the volume of system
Battery	Allowing you to read the battery status and set the system's idle time
Display	Allowing you to set the LCD's idle time and adjust the backlight of LCD
Bluetooth	Allowing you to search for a Bluetooth device around and pair the Bluetooth device with your product
System	Showing the information on the system's brief specification

Inserting a MiniSD Card

The GPS device is designed with a miniSD Card slot which allows you to insert the miniSD card into the GPS device.

To use the miniSD card, insert it into the slot of the device, with the connector pointing to the slot and its label facing the front of the device.

To remove the card, first make sure that no application is accessing the card, and then slightly push the top edge of the card to release and pull it out of the slot.



Note

1. *Make sure that no foreign object enters the miniSD card slot.*
2. *Keep a miniSD card in a well protective box to avoid dust and humidity when you are not using it.*

Connecting an Earphone

Connect an earphone to the left side of the device for private listening.

After the earphone is connected, the speaker of GPS device will be automatically off.



Caution

Excessively loud volume could damage your hearing. So turn down the volume before you connect the earphone, and then raise the volume to a comfortable level.

Chapter 3 Device Settings

You can customize the device settings, such as brightness, volume, date and time, etc. Once you change the settings, your new settings will remain until you change them next time.

To open the **Setup** menu, first tap the **Setup** icon on the main menu.



After you tap the **Setup** icon on the main menu, the **Setup** submenu will now appear in the display.

On this submenu you can set:

Clock – Adjusting the time zone, date, and time

Volume – Adjusting the system volume and enabling or disabling key tones

Battery – Displaying current battery status and adjust the battery idle time

Display – Adjusting the display idle time and brightness and calibrating the touch screen

Bluetooth – Searching, pairing, connecting a Bluetooth device

System – Viewing the system information, such as the information of firmware, CPU and the like



Clock

Tap **Clock** on the **Setup** submenu.



The **Clock** page appears in the display.



Time Zone

Firstly, tap the rectangle area of **Time Zone**.

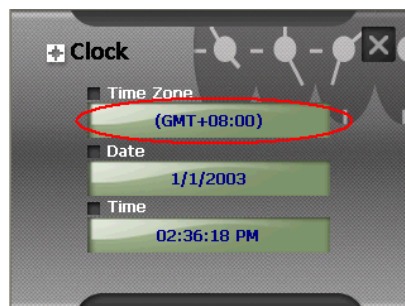

To change the time zone, tap the left/right arrow on the **Time Zone** bar.

Then, click **X** at the upper right corner of the page to save the setting and go back to the last page.



Date

Firstly, tap the rectangle area of **Date**.

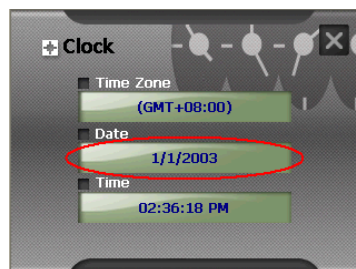

To change **Year**, **Month**, and **Day**, tap the left/right arrow on the **Date** bar.

Then, click **X** at the upper right corner of the page to save the setting and go back to the last page.



Time

Firstly, tap the rectangle area of **Time**.

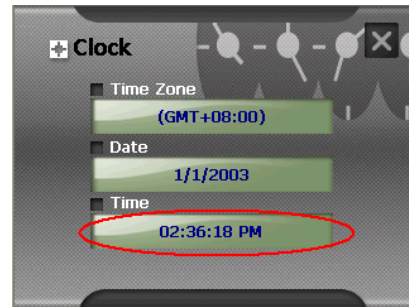

To change **Hour**, **Minute**, and **Second**, tap the left/right arrow on the **Time** bar.

Then, click **X** at the upper right corner of the page to save the setting and go back to the last page.



Volume

Tap **Volume** on the **Setup** submenu.



The **Volume** page appears in the display.



Check the **Enable Keytone** option if you would like to hear a clicking sound each time you tap on the display.

If you are using the earphone, the **Enable keytone** option will be disabled automatically.



Tap the + or – symbol to increase or decrease the volume.

Then, click  at the upper right corner of the page to save the setting and go back to the last page.

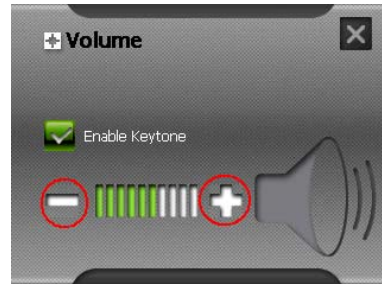

Battery

Tap **Battery** on the **Setup** submenu to check the remaining power of your battery and/or choose the idle time for power saving.



The **Power** page appears in the display.

Battery Status indicates the current status of battery. When the battery of GPS device is being charged, you see the indication of **Battery Status : Charging**; when the battery of GPS device is fully charged, you see the indication of **Battery Status : 100%**



Tap the right or left arrow to choose the idle time of power. You can set a timer to automatically turn off your device when it is idle for a set period of time. The options include **Never**, **1 min**, **2 min**, **5 min**, **10 min**, and **15 min**.

For power saving, you had better choose the idle time. If you choose the idle time, the device will be in the suspend mode at the time you set.

Then, click  at the upper right corner of the page to save the setting and go back to the last page.



Display

Tap **Display** on the **Setup** submenu.



The **Display** page appears in the display.

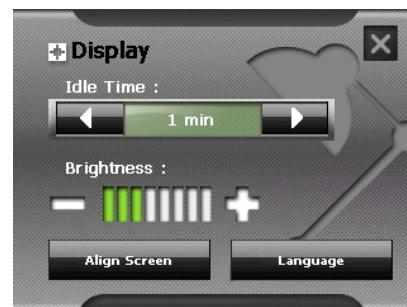

Tap the right or left arrow to choose the idle time of display. You can set a timer to automatically turn off your display when it is idle for a set period of time. The options include **Never**, **15 secs**, **30 secs**, **1 min**, **2 min**, and **5 min**.

For power saving, you had better choose the idle time. If you choose the idle time, the display will be turned off at the time you set.



Tap the **+** or **-** symbol to increase or decrease the brightness of display.



You can calibrate the touch screen if it is not responding accurately to your taps.

Click **Align Screen** to calibrate the touch screen.



You see a screen in a language you have set to. Tap and hold the center of the target. When the target moves to another position, tap and hold the center of the new target. Repeat each time to complete the calibration process.

Carefully press and briefly hold pointed tool on the center of the target. Repeat as the target moves over the screen.



Then, The **Display** page returns. Tap **Language** to choose another UI language.



Tap the right or left arrow to choose another language. The languages are English, French, and Spanish.



Then, click  at the upper right corner of the page to save the setting and go back to the **Display** page.

Bluetooth

Tap **Bluetooth** on the **Setup** submenu.



The **Bluetooth** page appears in the display. There are 2 tabs in the Bluetooth management, one for **Mode** and the other for **Devices**.



Mode – You can turn on/off Bluetooth and make your device to be discovered by other devices with Bluetooth.

Devices – You can manage all searched/paired devices.

If you finish in the setting, click  at the upper right corner of the page to save the setting and go back to the last page.



System

Tap **System** on the **Setup** submenu.



The **System Info** page appears in the display.

You can read the system information in this page, such as model name, firmware version, NAND Flash size, SDRAM size, and CPU type.

Click  at the upper right corner of the page to go back to the last page.

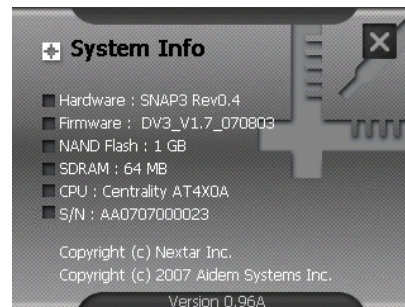

Chapter 4 Main Menu

Whenever switching ON the GPS device, you will see the main menu of system on the display. This main menu is the starting point where all of the functions exist for you to use. You can tap one of the functional icons to start the function you want. When the function exits, the system will take to the main menu of system.



Button Name	Description
Navigator	Entering the GPS navigation service
Photo	Allowing you to view pictures in the formats of BMP, JPG, and GIF that were stored in a miniSD card
MP3	Allowing you to enjoy songs in the formats of MP3 and WMA that were stored in a miniSD card
BT CarKit	Allowing you to talk on the device by means of Bluetooth wirelessly connected to your BT mobile phone
Calculator	Allowing you to do calculation
Setup	Entering to customize the device settings, such as backlight, volume, date and time, as briefly described below

Navigator

Tap **Navigator** on the main menu of the display.



After tapping the **Navigator** icon on the main menu, you enter the **Warning** page. If you agree on what is described on this page, click **I Agree**.

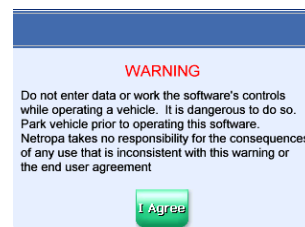

Note

For the detail of **Navigator** operation, please read the software user manual.

Photo

You can view photos or slideshow on your GPS device.

Tap **Photo** on the main menu of the display.

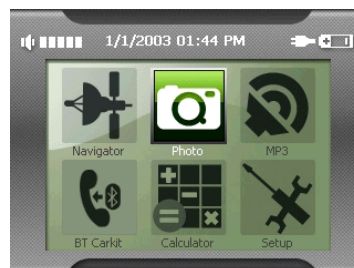

After tapping the **Photo** icon on the main menu, you enter the **Photo** page.



Features of Photo Viewer

- Codec Engine
 - ❑ Supports BMP, JPEG, and GIF formats
 - ❑ Supports 1 bit, 4 bits, 8 bits, 16 bits, 24 bits, and 32 bits bitmap images
 - ❑ Supports 8 bits and 24 bits JPEG images
 - ❑ Supports 8 bits interlace and non-interlace static GIF images
- Control Functions
 - ❑ Up one level, allowing you to surf the image files in the whole storage card
 - ❑ Home, allowing you to go quickly back to root of storage card
 - ❑ SlideShow
- Display
 - ❑ Thumbnail View
 - ❑ Image View
 - ❑ Slideshow View

Viewing Photos





If you cannot see photo thumbnails but instead folders (as shown in the figure above), then you can click one of the folders to access the contents (as shown in the illustration below).

You can also scroll up or down to search up or down the list of folders or photos.

Further, you can drag one of the photos, with a stylus, towards every column at the left side and every two columns at the right side; you can also drag it up and down.







You will see 4 functional options at the bottom of the screen, which are defined as follows:



-  Back button to move up to a level
-  Home button to return to the first level where you enter from the main menu
-  Slideshow button to show you photos in the slideshow mode
-  Exit from this page to main menu

Once you can see photos, you can click on one photo to show it at a full size.



You will see 8 functional options at the bottom of the screen, which are defined as follows:

-  Viewing a last photo
-  Viewing a next photo
-  Zoom in
-  Zoom out
-  Viewing a photo at the default rotation angle

-  Viewing a photo at 90° (clockwise)
-  View photo at 90° (anticlockwise)
-  Exiting the screen

Using the slideshow

Make sure that you can see photo thumbnails at the steps outlined in **Viewing Photos**.

Press the **Slideshow** button  and the slideshow will start.

To stop the slideshow, click everywhere on the screen.



MP3 Player

This section instructs you how to play MP3 files on your device.

Tap **MP3** on the main menu of the display.



After tapping the **MP3** icon on the main menu, you enter the **MP3 Player** page.



Features of MP3 Player:

- **Codec Engine**
 - Supports Win CE. NET 5.0 default (WMA and MP3)
 - Supports sampling frequencies from 8 kHz to 48 kHz
 - Minimum bit-rate supported 32kbps and Maximum bit-rate supported 320kbps or higher for layer-3
 - Supports variable bit rates

➤ **Control Functions**

- Play List Display
- Play/Pause/Stop/Forward/Backward
- Volume
- Repeat mode
 1. Repeat One
 2. Repeat All
- Shuffle

➤ **Display**



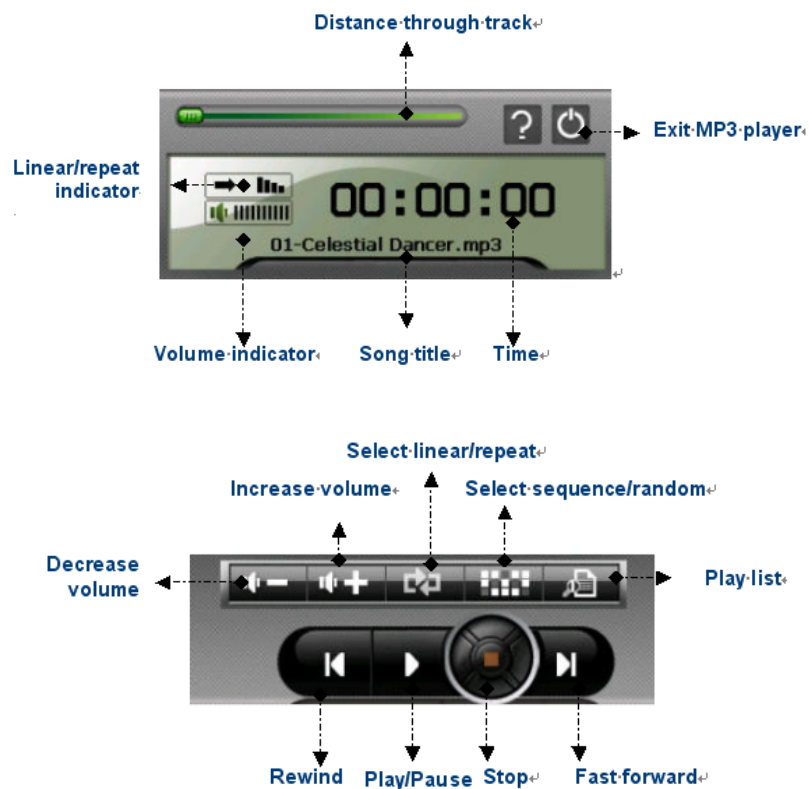

- Displays play time elapsing
- Track name ID3 support
- Index of current playing title

Definition of MP3 Player Buttons

The MP3 Player buttons are defined as follows.



Operation on MP3 Player

On the MP3 player, press the **Play** button  to begin listening to music. To pause the music, press the **Pause** button . To stop listening to the music, press the **Stop** button . To skip to a next track, press the **Fast forward** button . To go to the beginning of the current track or skip back to the previous track, press the **Rewind** button .

Adjusting the Player Volume

To adjust the volume, press the **Increase volume**  or **Decrease volume**  buttons.

Changing the order of tracks

To choose between playing tracks in sequential order or random order, press the **Select sequence/random** button. The current order is indicated at the upper right corner of the page.



Note

*The appearance of the **Select sequence/random** button changes with the current mode.*

Repeating tracks

To repeat a track or tracks or not, press the **Select linear/repeat** button. The current mode is indicated at the upper right corner of the page.



Note

*The appearance of the **Select sequence/random** button changes with the current mode.*

Displaying a play list

Press the **Play list**  button and then the **Play list** page appears on the display.





Note

By default, all tracks in the storage card will be added to the play list.

To update all tracks from the memory card, please press the **Update all tracks**  button. But MP3 Player will administrate this list automatically.

To add tracks, press the **Add track**  button and then navigate to the track/s you would like to add. And you can add several songs at the same time. This function is not used in the classified file.

To delete tracks, press the **Delete track**  button in the **My Favorite** folder. And you can delete several songs at the same time.

To return the previous page, press the **Return**  button.

BT Carkit

With BT Carkit, you can make a phone call or answer a phone call thru the GPS device.



Note

Before using this function, pair and connect a Bluetooth mobile phone with the GPS device through Bluetooth.

Tap **BT Carkit** on the main menu of the display.



After tapping the **BT Carkit** icon on the main menu, you enter the **BT Carkit** page.



Features of BT Carkit:

➤ Main Feature

- Supports dial pad
- Supports contact viewer
- Supports call history
- Supports phone shell, allowing you to pick up an incoming call

➤ Control Functions

- Digital keypad
- Backup
- Clear
- Dial / call history / contact viewer

➤ Display

- Displays phone number you want to dial out

Contact Viewer

Tap the **Contact Viewer** icon  to view the phone numbers of all your friends.



Features of Contacts Viewer:



- ✓ Supports **Add**  / **Edit**  / **Delete**  functions
- ✓ Supports dial out  from a list of contacts

Call History

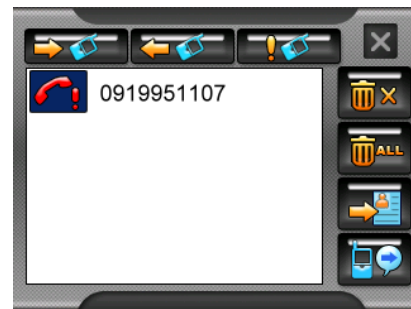
Tap the **Call History** icon  to view all the call history, including outgoing calls, incoming calls, and missed calls.



Features of Call History:

- ✓ Supports the **Delete**  function to delete all history functions
- ✓ Supports the **Save**  function to save the calls to history for contact
- ✓ Supports the **Quick Dial**  function, allowing you to very easily dial out from the call history

Phone Shell

The phone shell program allows you to dial out and pick up an incoming call.



Calculator

Tap **Calculator** on the main menu of the display.



After tapping the **Calculator** icon on the main menu, you enter the **Calculator** page.



The calculator tool turns your device into a calculator. The calculator tool is easy to use, so you can press every button with your fingertips.

Features of Calculator:

- ✓ Supports basic calculation, such as addition, subtraction, multiplication, division, square, and square root
- ✓ Supports memory function, such as MC, MR, M+ and M-
- ✓ Supports 12 digits as the maximum calculation result